

Product data sheet

Characteristics

XS4P18AB110

Inductive proximity sensors XS, inductive sensor XS4 M18, L41mm, PBT, Sn8mm, 24...48 VDC, cable 2 m



Product availability: Stock - Normally stocked in distribution facility

Price*: 212.19 USD



Main

Range of product	Telemecanique Inductive proximity sensors XS
Series name	Application
Sensor type	Inductive proximity sensor
Electrical circuit type	Analog output
Sensor name	XS4
Sensor design	Cylindrical M18
Size	41 mm
Body type	Fixed
Detector flush mounting acceptance	Non flush mountable
Material	Plastic
Type of output signal	Analogue
Wiring technique	3-wire
[Sn] nominal sensing distance	0.31 In (8 mm)
Output circuit type	DC
Analogue output range	0...10 V
Electrical connection	Cable
Cable length	6.56 Ft (2 m)
[Us] rated supply voltage	24...48 V DC
IP degree of protection	IP67 conforming to IEC 60529

Complementary

Thread type	M18 x 1
Detection face	Frontal
Front material	PPS
Enclosure material	PBT
Operating zone	0.03...0.31 In (0.8...8 mm)
Repeat accuracy	<= 3% of Sr
Linearity error	+/- 2 mA

Cable composition	3 x 0.34 mm ²
Wire insulation material	PvR
Supply voltage limits	15...58 V DC
Switching frequency	<= 500 Hz
Current consumption	4 mA no-load
Maximum output current drift	10 %
Marking	CE
Threaded length	1.02 ln (26 mm)
Height	0.71 ln (18 mm)
Length	1.61 ln (41 mm)
Net weight	0.18 Lb(US) (0.08 kg)

Environment

Product certifications	UL CCC CSA
Ambient air temperature for operation	-13...158 °F (-25...70 °C)

Ordering and shipping details

Category	22486 - SENSORS, PROXIMITY
Discount Schedule	DS2
GTIN	03389110335323
Nbr. of units in pkg.	1
Package weight(Lbs)	2.86 Oz (81 g)
Returnability	Yes
Country of origin	FR

Packing Units

Unit Type of Package 1	PCE
Package 1 Height	5.20 ln (13.2 cm)
Package 1 width	3.74 ln (9.5 cm)
Package 1 Length	1.61 ln (4.1 cm)
Unit Type of Package 2	BAG
Number of Units in Package 2	1
Package 2 Weight	3.42 Oz (97 g)
Package 2 Height	1.18 ln (3 cm)
Package 2 width	7.87 ln (20 cm)
Package 2 Length	5.91 ln (15 cm)
Unit Type of Package 3	S03
Number of Units in Package 3	44
Package 3 Weight	10.47 Lb(US) (4.75 kg)
Package 3 Height	11.81 ln (30 cm)
Package 3 width	11.81 ln (30 cm)
Package 3 Length	15.75 ln (40 cm)

Offer Sustainability

Sustainable offer status	Green Premium product
California proposition 65	WARNING: This product can expose you to chemicals including: Diisononyl phthalate (DINP), which is known to the State of California to cause cancer, and Diisodecyl phthalate (DIDP), which is known to the State of California to cause birth defects or other reproductive harm. For more information go to www.P65Warnings.ca.gov
REACH Regulation	REACH Declaration
EU RoHS Directive	Pro-active compliance (Product out of EU RoHS legal scope) EU RoHS Declaration
Mercury free	Yes
RoHS exemption information	Yes
Environmental Disclosure	Product Environmental Profile
Circularity Profile	End Of Life Information

Contractual warranty

Warranty	18 months
----------	-----------

Dimensions

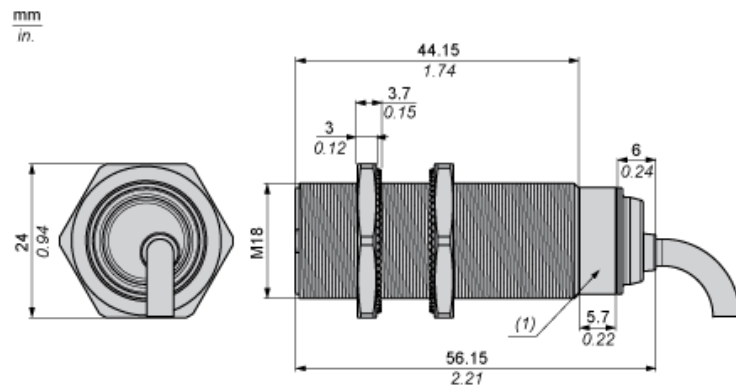

(1) LED

Minimum Mounting Distances

Side by side



e (1) \geq 2 mm/1.26 in.

Face to face

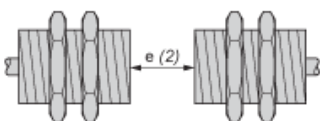

e (2) \geq 6 mm/3.78 in.

Facing a metal object

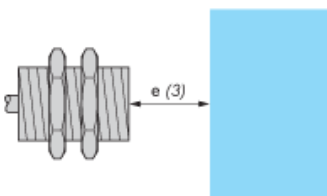

e (3) \geq 4 mm/0.94 in.

Mounted in a metal support

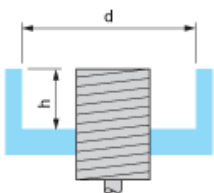

d \geq 56 mm/2.20 in.

h \geq 16 mm/0.63 in.

Mounting

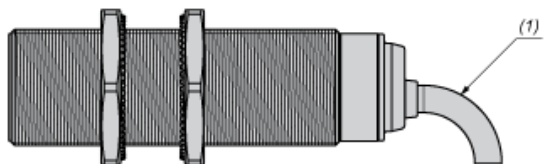

(1) Bending cable: 4 x external cable diameter

Wiring Schemes

3-Wire connection

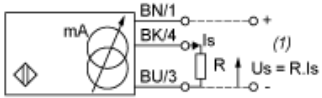

(1) Voltage output

BN : Brown

BK : Black

BU : Blue

	Output current	Load impedance value	Output voltage	Load impedance value
24 V	0...10 mA	$R \leq 1500 \Omega$	0...10 V	$R = 1000 \Omega$
48 V	0...10 mA	$R \leq 3300 \Omega$	0...10 V	$R = 1000 \Omega$

Output Curves

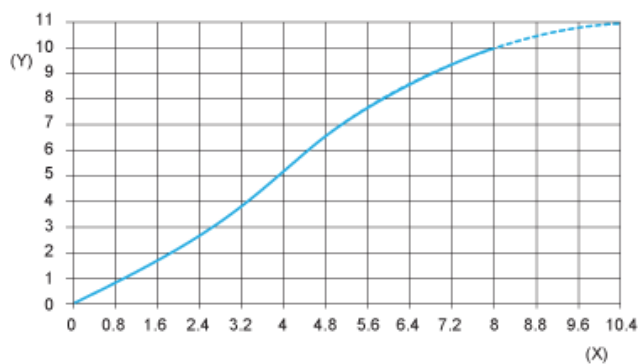

(Y) Is (V)

(X) Sensors - object distance (mm)

Product Life Status : **Commercialised**